

# 80 VJR / 100 VJR









TECHNICAL DATA SHEET



 **MANITOU**

[www.manitou.com](http://www.manitou.com)

# 80 VJR / 100 VJR

|  | 80 VJR             | 100 VJR |
|--|--------------------|---------|
|  <b>Working height</b>            | 7.70 m             | 9.90 m  |
| <b>Platform height</b>   | 5.70 m             | 7.90 m  |
| <b>Articulation height</b>   | 4.23 m             | 6.67 m  |
| <b>Outreach</b>  | 3.25 m             | 3.15 m  |
|  <b>Jib tilting</b>               | +70° / - 70°       |         |
| <b>Basket rotation</b>   | +70° / - 70°       |         |
| <b>Turret rotation</b>   | 350°               |         |
|  <b>Capacity</b>                  | 200 kg             |         |
| <b>Number of persons (indoor/outdoor)</b>  | 2/1                |         |
| <b>Basket (width and length)</b>   | 0.90 x 0.75 m      |         |
|  <b>1. Overall width</b>          | 0.99 m             |         |
| <b>2. Overall length</b>   | 2.95 m             | 2.82 m  |
| <b>3. Overall height</b>   | 1.99 m             |         |
| <b>4. Interior turning circle</b>  | 0.49 m             |         |
| <b>5. Exterior turning circle</b>  | 1.98 m             |         |
| <b>6. Ground clearance</b>   | 10 cm              |         |
| <b>7. Wheelbase</b>  | 1.20 m             |         |
|  <b>Speed of forward movement</b> | 4.50 kph           |         |
| <b>Working speed</b>   | 0.65 kph           |         |
|  <b>Maximum slope accessible</b>  | 25 %               |         |
| <b>Maximum tilt</b>  | 3.5 % / 2°         |         |
|  <b>Tyres</b>                     | 16-5-11 1/4        |         |
| <b>Driving wheels</b>  | 2 (back)           |         |
| <b>Steering/directional wheels</b>   | 2 (front)          |         |
|  <b>Weight</b>                    | 2250 kg            | 2650 kg |
| (varies according to options & standards of the country)   |                    |         |
|  <b>Batteries</b>                 | 250 Ah (C5) / 24 V |         |
| <b>Integrated charger</b>  | 30 Ah / 24 V       |         |

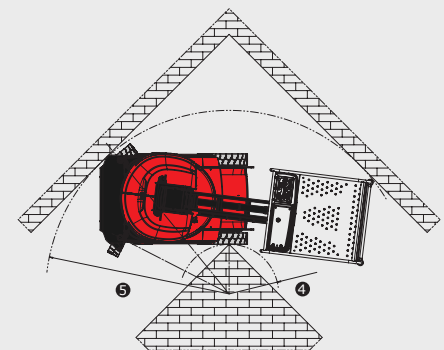
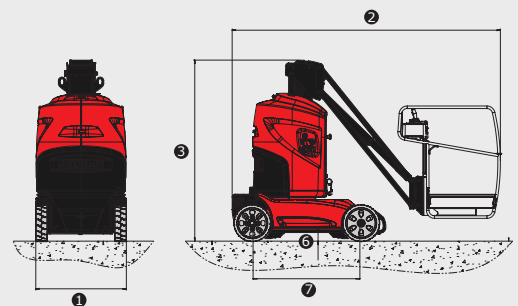
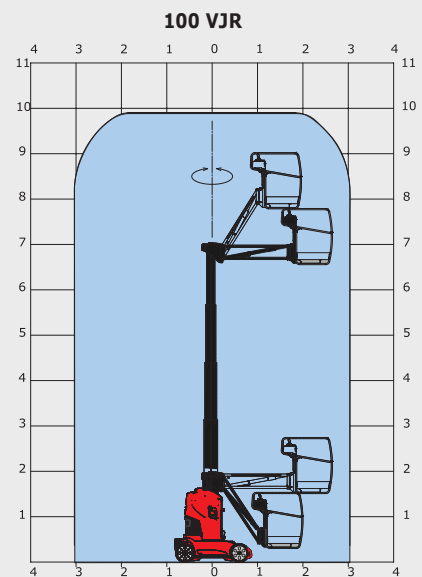
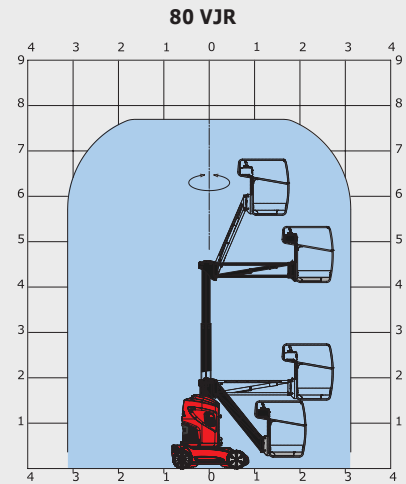

## Standard equipment

- Proportional switches/levers
- Forward movement possible at maximum height
- Sound and visual alarm in case of excessive slant and overload
- Integrated charger
- Emergency manual descent
- Negative braking system
- Sound warning system inside the platform
- Hour meter
- Indication of state of charge of batteries
- Hooks for sling loading/lifting
- Integrated diagnostic aid
- Tyres with non-marking edges
- Tyres crimped non-marking wheels
- All-road non-marking wheels
- Basket with transparent floor
- Bus CAN technology
- Tool box inside platform

## Optional equipment

- Flashing lights
- Working light
- Predisposition of air
- Predisposition of water
- 230V power input with differential circuit-breaker
- Special paint
- Biodegradable oil
- Central topping-up of batteries
- Initial certificate of verification prior to entry into service
- Safety harness
- Oil for extreme low temperatures
- Battery frost protection

This brochure describes versions and configuration options for MANITOU products which may be fitted with different equipment. The equipment described in this brochure may be standard, optional or not available depending on version. MANITOU reserves the right to change the specifications shown and described at any time and without prior warning. The manufacturer is not liable for the specifications given. For more information, contact your MANITOU dealer. Non-contractual document. Product descriptions may differ from actual products. List of specifications is not comprehensive. The logos and visual identity of the company are the property of MANITOU and may not be used without authorisation. All rights reserved. The photos and diagrams contained in this brochure are provided for information only.

MANITOU BF SA - Limited company with board of directors - Share capital: 39,547,824 euros - 857 802 508 RCS Nantes

